



Evolve 2 is de opvolger van de populaire Evolve straler en de referentie onder de led stralers vanwege zijn hoge kwaliteit, duurzaamheid en gebruiksgemak. Evolve 2 is uitgerust met Lumileds SMD3030 chips met een efficiëntie tot 150lm/W bij 4000K en een levensduur L90 >60.000u . De aluminium IP66 behuizing, geschikt voor corrosieve omgevingen en zeezout, is voorzien van een Interpon coating en standaard voorzien van L316 schroeven, een mat veiligheidsglas en een interne 120° reflector. De leds worden aangestuurd door een interne dubbel geïsoleerde en flickervrije kwaliteitsdriver. Evolve 2 is aan de achterzijde voorzien van een ruime connectiebox met M20 in- en uitgang en toolless aansluitklemmen. Geen gedoe meer met aparte aftakdozen op de muur. Door de M20 eindstop te vervangen door een extra wartel (ref. EV2M20) is het toestel eveneens geschikt voor doorvoerbedrading! Met de toolless schroeven met richthoek aanduiding kan Evolve 2 eenvoudig gericht worden. Verschillende toebehoren voor grond- of paalmontage zijn beschikbaar alsook verschillende symmetrische/asymmetrische lenzen. 5 jaar garantie. Op aanvraag leverbaar met dimbare driver 1-10V/DALI.

														
IP66	IK08	60	5	tot 148	0,98	> 60.000 L90	JA	82	4000	DALI	SMD3030	28	JA	JA

Technische eigenschappen

Referentie	EV200B604DA
EAN code	5420076285395
ETIM code	EC001744

Elektrische eigenschappen

System vermogen (W)	197,5
LED vermogen (W)	199,96
Aansluitspanning (Vac)	220-240
Frequentie (Hz)	50/60
Driver inbegrepen	ja
Driver intern/extern	intern
Driver merk	Inventronics
Driver type	
Dimbaar	DALI
Flicker free	ja
Power factor	0,98
THD	
Driver output (V)	
Driver output (mA)	
Isolatieklasse	I
Energie klasse	D
Aantal op 16A B curve	
Aantal op 16A C curve	3
Aantal op 16A D curve	5
Inrush current driver	145A 584µs

Garantie en certificatie

ENEC	ja
Garantie (jaar)	5 (exclusief batterijen)

Lichttechnische eigenschappen

Lichtbundel(°)	60
Kleurtemperatuur (K)	4000
Kleurweergave CRI	82
UGR	28
Kleurvastheid SDCM	3
Lumen output (Lm)	29691
Lm/W	148
Flux code	85 97 99 100 104
Ledchip	SMD3030
Ledfabrikant	Lumileds
Aantal LEDs	320
Fotobiologische klasse	RG1

Afmeting en materiaal eigenschappen

Afmetingen (LxBxH)	385x74x470mm
Gewicht (kg)	7,13
Kleur	zwart
Werktemperatuur (°C)	-30~+45
IP waarde	IP66
IK waarde	IK08
UV bestendig	ja
Zeewater bestendig	ja
UL 94	
Aantal in bulk	2
Aantal op pallet	
Minimum bestelaantal	1
Stockartikel	ja

EV200B604DA - Evolve2 200W 4000K 60gr zwart DALI ENEC

Lumen distribution

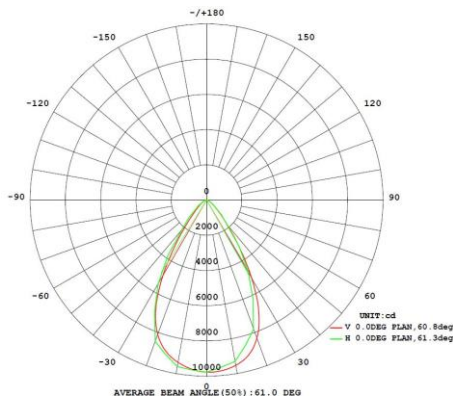

Distance curve:

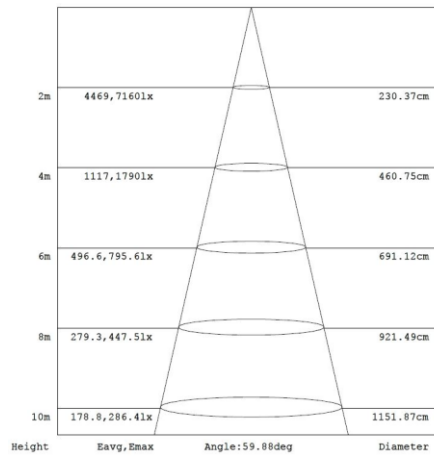

Spectrum distribution

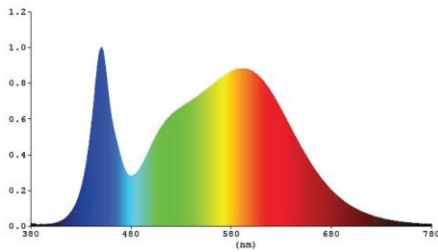

Lumendrop

Model:	EV25B4	EV45B4	EV75B4	EV100B4
Time (t) at which to estimate lumen maintenance (hours):	50000	50000	50000	50000
Lumen maintenance at time (t) (%):	94.72%	94.72%	94.72%	94.72%
Reported L90 (hours):	>60000	>60000	>60000	>60000
Reported L70 (hours):	>60000	>60000	>60000	>60000

Model:	EV150B4	EV200B4	EV240B4	EV240H OB4
Time (t) at which to estimate lumen maintenance (hours):	50000	50000	50000	50000
Lumen maintenance at time (t) (%):	94.72%	94.72%	94.72%	94.72%
Reported L90 (hours):	>60000	>60000	>60000	>60000
Reported L70 (hours):	>60000	>60000	>60000	>60000

Afmetingen

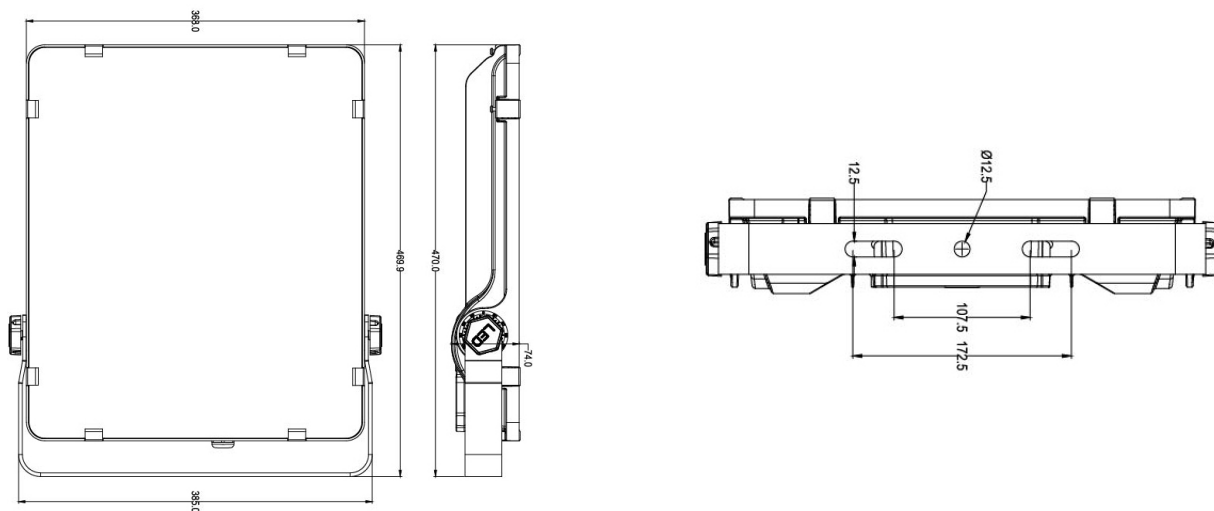

Aansluitschema

