

















De Food Highbay serie is ontworpen om te voldoen aan de eisen van de voedselverwerkende industrie en voldoet aan de FDA richtlijnen. De corrosiebestendige en niet-toxische behuizing van aluminium is volledig glad en gemakkelijk schoon te maken. De beschermingsklasse IP69K maakt de Food Highbay makkelijk te reinigen en geschikt voor gebruik in gebieden met een hoge luchtvochtigheid. De opmerkelijk systeemefficiëntie tot 140lm/W zal de energiekosten aanzienlijk verlagen. Optionele functies, zoals een geïntegreerde bewegingssensor of opaal cover vergroten de bruikbaarheid van dit armatuur nog meer. De Food highbay is o.a. geschikt voor toepassingen in de voedselindustrie zoals verwerking van bloem of suiker, clean-room toepassingen enz.

														
IP69K	IK08	110	5	tot 140	>0,9	50.000 L80B10	JA	>85	4000	1-10V	JMILEDS 303	<25	NEE	NEE

### Technische eigenschappen

Referentie	FHBP1504
EAN code	5420076263959
ETIM code	EC001716

### Elektrische eigenschappen

Systeem vermogen (W)	150
LED vermogen (W)	140
Aansluitspanning (Vac)	100-277
Frequentie (Hz)	47-63
Driver inbegrepen	ja
Driver intern/extern	intern
Driver merk	Tomcarline
Driver type	R150
Dimbaar	1-10V
Flicker free	ja
Power factor	>0,9
Aansluitkabel	2m H05RN-F
Driver output (V)	
Driver output (mA)	
Isolatieklasse	I
Energie klasse	A+
Aantal op 16A C curve	7
Aantal op 16A D curve	
Inrush current driver	62A 423µs

### Garantie en certificatie

ENEC	nee
Garantie (jaar)	5 (exclusief batterijen)
TM-21	Lifetime Temp Tc
L80B10	50.000 55°C

### Lichttechnische eigenschappen

Lichtbundel(°)	110
Kleurtemperatuur (K)	4000
Kleurweergave CRI	>85
UGR	<25
Kleurvastheid SDCM	<5
Lumen output (Lm)	21000
Lm/W	140
Flux code	
Ledchip	LUMILEDS 3030

Ledfabrikant	Lumileds
Aantal LEDs	280
Fotobiologische klasse	RG1

### Afmeting en materiaal eigenschappen

Afmetingen (LxBxH)	460x460x177mm
Gewicht (kg)	5,5
Kleur	wit
Werktemperatuur (°C)	-30~+50
IP waarde	IP69K
IK waarde	IK08
UV bestendig	ja
Zeewater bestendig	nee
UL 94	
Aantal in bulk	1
Aantal op pallet	
Minimum bestelaantal	1
Stockartikel	nee

## FHBP1504 - FHBP food 150W 4000K IP69K 1-10V

### Lumen distribution

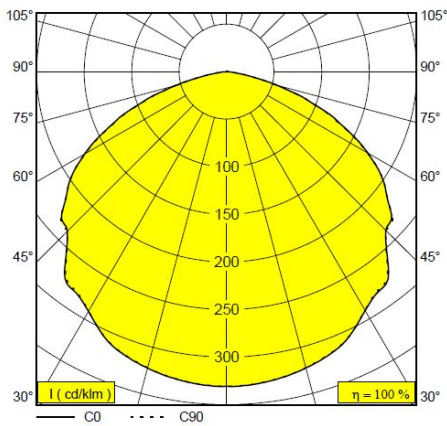

### Distance curve:

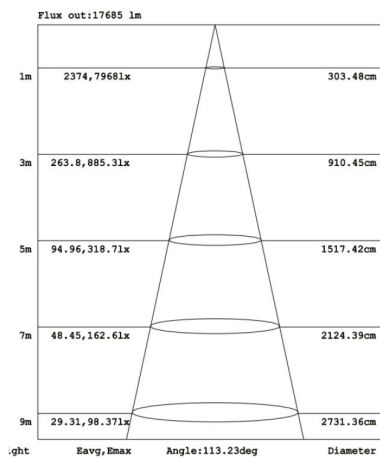

### Spectrum distribution

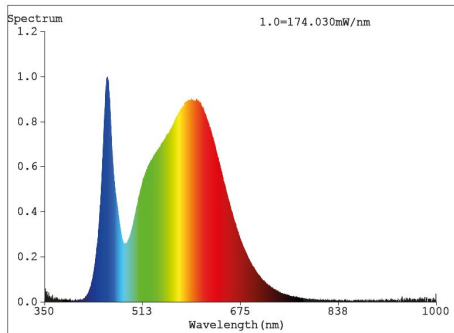

### Lumendrop

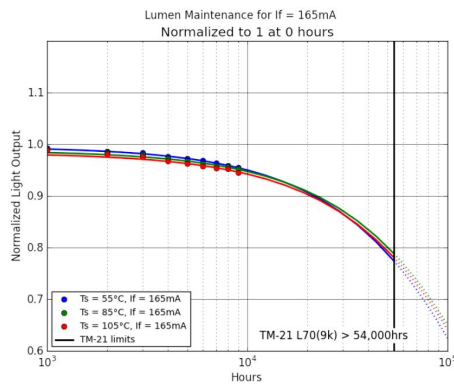

### Accessoires

FHBPPIR	PIR sensor IP65 max 12m voor FHBP
FHBPMW	Microwave sensor IP65 max 15m voor FHBP
INT-REMOTE	Integratech universal sensor remote control



### Afmetingen

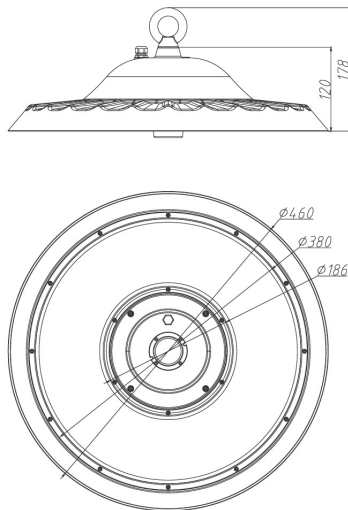

### Aansluitschema

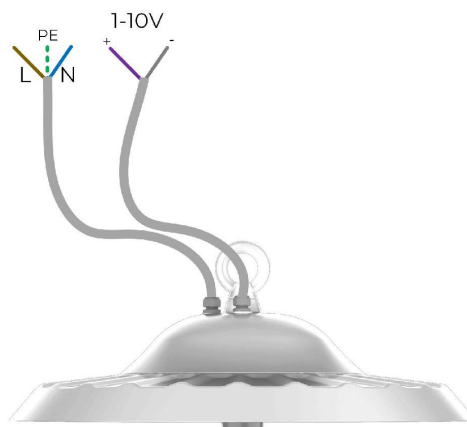

### Certificates

CE (EMC, LVD, RoHS), TUV, CB, D-Mark  
NSF Food certificate