















Solide armatuur (IK10/IP65) met zeer hoge levensduur, uitgerust met kwaliteitsdrivers en performante ledchips, efficiëntie tot 150lm/W afhankelijk van type lens. Ingebouwde overspanningsbeveiliging. Bijzonder geschikt voor high-end toepassingen zoals sportvelden waar veel licht nodig is met een minimum aan verblinding en lichtverstrooiing. Opties DALI dimbaar, aparte driverbox, valbeveiliging, louvre en lasertool voor precisie afstelling.

								>70 icon" data-bbox="516 295 569 335"/>					
IP66	IK10	15	5	tot 130	>0.95	50.000 L80B50	Flicker-Free	>70	4000	DIM	SMD3535	NEE	NEE

### Technische eigenschappen

Referentie	ITSP2300154000
EAN code	5404042502068
ETIM code	EC001744

### Elektrische eigenschappen

Systeem vermogen (W)	300
LED vermogen (W)	
Aansluitspanning (Vac)	100-277
Frequentie (Hz)	50/60
Driver inbegrepen	ja
Driver intern/extern	extern
Driver merk	inventronics
Driver type	
Dimbaar	
Flicker free	nee
Power factor	>0.95
THD	
Driver output (V)	
Driver output (mA)	
Isolatieklasse	
Energie klasse	E
Aantal op 16A B curve	
Aantal op 16A C curve	
Aantal op 16A D curve	
Inrush current driver	

### Garantie en certificatie

ENEC	nee
Garantie (jaar)	5 (exclusief batterijen)

### Lichttechnische eigenschappen

Lichtbundel(°)	15
Kleurtemperatuur (K)	4000
Kleurweergave CRI	>70
UGR	
Kleurvastheid SDCM	
Lumen output (Lm)	39000
Lm/W	130
Flux code	
Ledchip	SMD3535
Ledfabrikant	
Aantal LEDs	
Fotobiologische klasse	

### Afmeting en materiaal eigenschappen

Afmetingen (LxBxH)	454x509x425mm
Gewicht (kg)	17,2
Kleur	zwart
Werktemperatuur (°C)	-40~+50
IP waarde	IP66
IK waarde	IK10
UV bestendig	nee
Zeewater bestendig	nee
UL 94	
Aantal in bulk	
Aantal op pallet	
Minimum bestelaantal	1
Stockartikel	nee
EPA	

### Lumen distribution

### Distance curve:

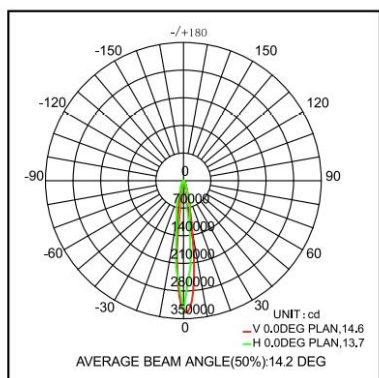

15°

### Spectrum distribution

### Lumendrop

# DATASHEET

ITSP2300154000 - ITSP2 300W 15gr 4000K IP66 IK10 zwart

---

## Afmetingen

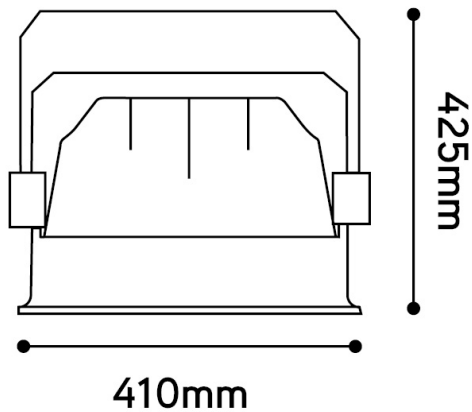

## Aansluitschema