

















Solide armatuur (IK10/IP65) met zeer hoge levensduur, uitgerust met kwaliteitsdrivers en performante ledchips, efficiëntie tot 150lm/W afhankelijk van type lens. Ingebouwde overspanningsbeveiliging. Bijzonder geschikt voor high-end toepassingen zoals sportvelden waar veel licht nodig is met een minimum aan verblinding en lichtverstrooiing. Opties DALI dimbaar, aparte driverbox, valbeveiliging, louvre en lasertool voor precisie afstelling.

													
IP66	IK10	45	5	tot 143	>0.95	50.000 L80B50	Flicker-Free	>70	3000	DIM	SMD5050	NEE	NEE

Technische eigenschappen

Referentie	ITSP2300453000
EAN code	5404042502099
ETIM code	EC001744

Elektrische eigenschappen

Systeem vermogen (W)	300
LED vermogen (W)	
Aansluitspanning (Vac)	100-277
Frequentie (Hz)	50/60
Driver inbegrepen	ja
Driver intern/extern	extern
Driver merk	inventronics
Driver type	
Dimbaar	
Flicker free	nee
Power factor	>0.95
THD	
Driver output (V)	
Driver output (mA)	
Isolatieklasse	
Energie klasse	D
Aantal op 16A B curve	
Aantal op 16A C curve	
Aantal op 16A D curve	
Inrush current driver	

Garantie en certificatie

ENEC	nee
Garantie (jaar)	5 (exclusief batterijen)

Lichttechnische eigenschappen

Lichtbundel(°)	45
Kleurtemperatuur (K)	3000
Kleurweergave CRI	>70
UGR	
Kleurvastheid SDCM	
Lumen output (Lm)	42900
Lm/W	143
Flux code	
Ledchip	SMD5050
Ledfabrikant	
Aantal LEDs	
Fotobiologische klasse	

Afmeting en materiaal eigenschappen

Afmetingen (LxBxH)	454x509x425mm
Gewicht (kg)	17,2
Kleur	zwart
Werktemperatuur (°C)	-40~+50
IP waarde	IP66
IK waarde	IK10
UV bestendig	nee
Zeewater bestendig	nee
UL 94	
Aantal in bulk	
Aantal op pallet	
Minimum bestelaantal	1
Stockartikel	nee
EPA	

Lumen distribution

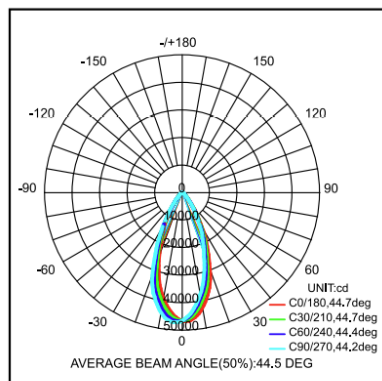

45°

Spectrum distribution

Distance curve:

Lumendrop

Afmetingen

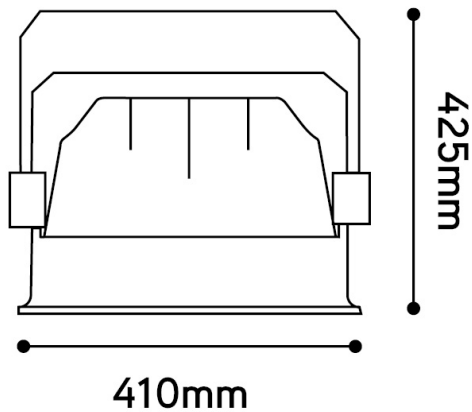

Aansluitschema