















Solide armatuur (IK10/IP65) met zeer hoge levensduur, uitgerust met kwaliteitsdrivers en performante ledchips, efficiëntie tot 150lm/W afhankelijk van type lens. Ingebouwde overspanningsbeveiliging. Bijzonder geschikt voor high-end toepassingen zoals sportvelden waar veel licht nodig is met een minimum aan verblinding en lichtverstrooiing. Opties DALI dimbaar, aparte driverbox, valbeveiliging, louvre en lasertool voor precisie afstelling.

								>70 icon" data-bbox="516 296 569 335"/>					
IP66	IK10	15	5	tot 130	>0.95	50.000 L80B50	Flicker-Free	>70	4000	DIM		NEE	NEE

Technische eigenschappen

Referentie	ITSP2700154000
EAN code	5404042502549
ETIM code	EC001744

Elektrische eigenschappen

Systeem vermogen (W)	
LED vermogen (W)	
Aansluitspanning (Vac)	
Frequentie (Hz)	
Driver inbegrepen	ja
Driver intern/extern	extern
Driver merk	inventronics
Driver type	
Dimbaar	
Flicker free	nee
Power factor	>0.95
THD	
Driver output (V)	
Driver output (mA)	
Isolatieklasse	
Energie klasse	E
Aantal op 16A B curve	
Aantal op 16A C curve	
Aantal op 16A D curve	
Inrush current driver	

Garantie en certificatie

ENEC	nee
Garantie (jaar)	5 (exclusief batterijen)

Lichttechnische eigenschappen

Lichtbundel(°)	15
Kleurtemperatuur (K)	4000
Kleurweergave CRI	>70
UGR	
Kleurvastheid SDCM	
Lumen output (Lm)	91000
Lm/W	130
Flux code	
Ledchip	
Ledfabrikant	
Aantal LEDs	
Fotobiologische klasse	

Afmeting en materiaal eigenschappen

Afmetingen (LxBxH)	554x593x566mm
Gewicht (kg)	28,7
Kleur	zwart
Werktemperatuur (°C)	
IP waarde	IP66
IK waarde	IK10
UV bestendig	nee
Zeewater bestendig	nee
UL 94	
Aantal in bulk	1
Aantal op pallet	
Minimum bestelaantal	1
Stockartikel	nee
EPA	

Lumen distribution

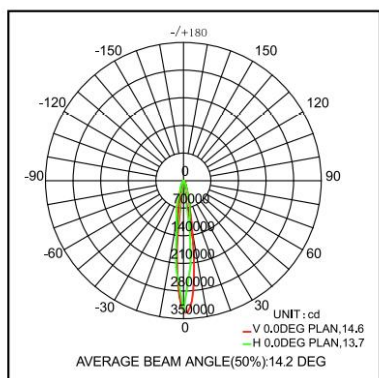

15°

Spectrum distribution

Distance curve:

Lumendrop

Afmetingen

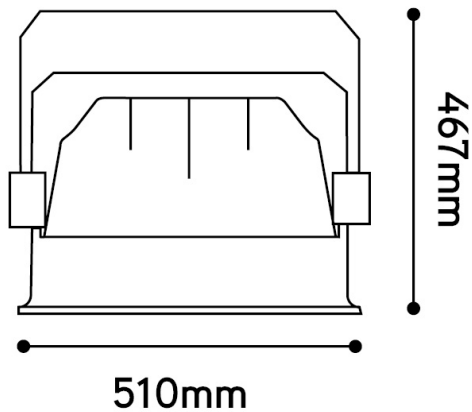

Aansluitschema