















Solide armatuur (IK10/IP65) met zeer hoge levensduur, uitgerust met kwaliteitsdrivers en performante ledchips, efficiëntie tot 150lm/W afhankelijk van type lens. Ingebouwde overspanningsbeveiliging. Bijzonder geschikt voor high-end toepassingen zoals sportvelden waar veel licht nodig is met een minimum aan verblinding en lichtverstrooiing. Opties DALI dimbaar, aparte driverbox, valbeveiliging, louvre en lasertool voor precisie afstelling.

								>70 icon" data-bbox="516 295 569 335"/>					
IP66	IK10	30	5	tot 143	>0.95	50.000 L80B50	Flicker-Free	>70	3000	DIM		NEE	NEE

Technische eigenschappen

Referentie	ITSP2700303000
EAN code	5404042502556
ETIM code	EC001744

Elektrische eigenschappen

Systeem vermogen (W)	
LED vermogen (W)	
Aansluitspanning (Vac)	
Frequentie (Hz)	
Driver inbegrepen	ja
Driver intern/extern	extern
Driver merk	inventronics
Driver type	
Dimbaar	
Flicker free	nee
Power factor	>0.95
THD	
Driver output (V)	
Driver output (mA)	
Isolatieklasse	
Energie klasse	D
Aantal op 16A B curve	
Aantal op 16A C curve	
Aantal op 16A D curve	
Inrush current driver	

Garantie en certificatie

ENEC	nee
Garantie (jaar)	5 (exclusief batterijen)

Lichttechnische eigenschappen

Lichtbundel(°)	30
Kleurtemperatuur (K)	3000
Kleurweergave CRI	>70
UGR	
Kleurvastheid SDCM	
Lumen output (Lm)	100100
Lm/W	143
Flux code	
Ledchip	
Ledfabrikant	
Aantal LEDs	
Fotobiologische klasse	

Afmeting en materiaal eigenschappen

Afmetingen (LxBxH)	554x593x566mm
Gewicht (kg)	28,7
Kleur	zwart
Werktemperatuur (°C)	
IP waarde	IP66
IK waarde	IK10
UV bestendig	nee
Zeewater bestendig	nee
UL 94	
Aantal in bulk	1
Aantal op pallet	
Minimum bestelaantal	1
Stockartikel	nee
EPA	

Lumen distribution

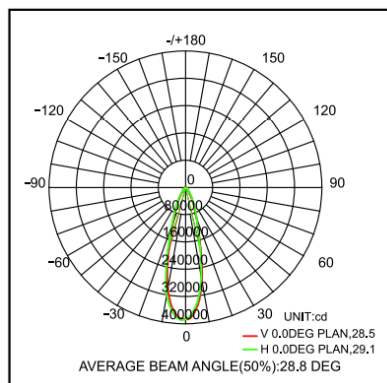

30°

Spectrum distribution

Distance curve:

Lumendrop

Afmetingen

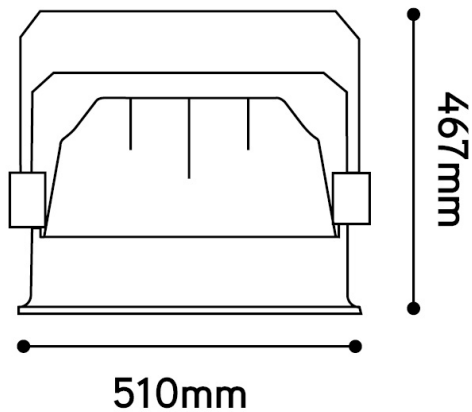

Aansluitschema