

















Solide armatuur (IK08/IP65) met modules die individueel 360° geroteerd kunnen worden. Zeer hoge levensduur, uitgerust met kwaliteitsdrivers en performante ledchips, efficiëntie tot 150lm/W afhankelijk van type lens. Ingebouwde overspanningsbeveiliging. Bijzonder geschikt voor high-end toepassingen zoals sportvelden waar veel licht nodig is met een minimum aan verblinding en lichtverstrooiing. Opties DALI dimbaar, aparte driverbox, valbeveiliging, louvre en lasertool voor precisie afstelling.

| | | | | | | | | | | | | | | |
|---|---|---|---|---|---|---|---|---|---|--|---|---|---|---|
|  |  |  |  |  |  |  |  |  |  |  |  |  |  |  |
| IP66 | IK10 | 60 | Garantie | tot 150 | >0.95 | > 100.000 L80B50 | Flicker-Free | >70 | 4000 | DIM | | | ENEC | STOCK |

Technische eigenschappen

| | |
|------------|-----------------|
| Referentie | ITSP31000604000 |
| EAN code | 5404042501221 |
| ETIM code | |

Elektrische eigenschappen

| | |
|------------------------|--------------|
| Systeem vermogen (W) | 1000 |
| LED vermogen (W) | |
| Aansluitspanning (Vac) | 100-277 |
| Frequentie (Hz) | 50/60 |
| Driver inbegrepen | ja |
| Driver intern/extern | extern |
| Driver merk | Inventronics |
| Driver type | |
| Dimbaar | |
| Flicker free | nee |
| Power factor | >0.95 |
| THD | |
| Driver output (V) | |
| Driver output (mA) | |
| Isolatieklasse | I |
| Energie klasse | D |
| Aantal op 16A B curve | |
| Aantal op 16A C curve | |
| Aantal op 16A D curve | |
| Inrush current driver | |

Garantie en certificatie

| | |
|-----------------|------------------------|
| ENEC | nee |
| Garantie (jaar) | (exclusief batterijen) |

Lichttechnische eigenschappen

| | |
|------------------------|--------|
| Lichtbundel(°) | 60 |
| Kleurtemperatuur (K) | 4000 |
| Kleurweergave CRI | >70 |
| UGR | |
| Kleurvastheid SDCM | |
| Lumen output (Lm) | 150000 |
| Lm/W | 150 |
| Flux code | |
| Ledchip | |
| Ledfabrikant | |
| Aantal LEDs | |
| Fotobiologische klasse | |

Afmeting en materiaal eigenschappen

| | |
|----------------------|---------------|
| Afmetingen (LxBxH) | 815x706x213mm |
| Gewicht (kg) | 31,5 |
| Kleur | |
| Werktemperatuur (°C) | |
| IP waarde | IP66 |
| IK waarde | IK10 |
| UV bestendig | nee |
| Zeewater bestendig | nee |
| UL 94 | |
| Aantal in bulk | 1 |
| Aantal op pallet | |
| Minimum bestelaantal | 1 |
| Stockartikel | nee |
| EPA | |

Lumen distribution

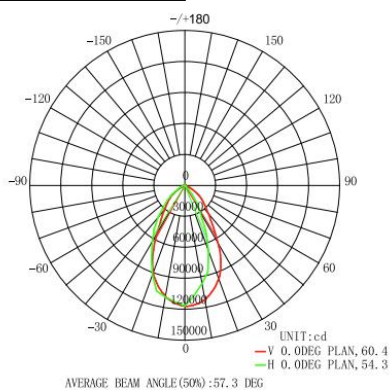

60°

Distance curve:

Spectrum distribution

Lumendrop

Afmetingen

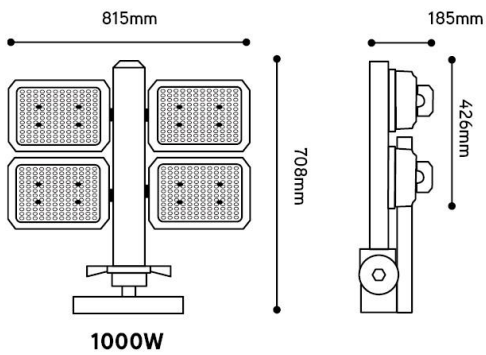

Aansluitschema