

















Solide armatuur (IK08/IP65) met modules die individueel 360° geroteerd kunnen worden. Zeer hoge levensduur, uitgerust met kwaliteitsdrivers en performante ledchips, efficiëntie tot 150lm/W afhankelijk van type lens. Ingebouwde overspanningsbeveiliging. Bijzonder geschikt voor high-end toepassingen zoals sportvelden waar veel licht nodig is met een minimum aan verblinding en lichtverstrooiing. Opties DALI dimbaar, aparte driverbox, valbeveiliging, louvre en lasertool voor precisie afstelling.

														
IP66	IK10	117X34	Garantie	tot 143	>0.95	> 100.000 L80B50	Flicker-Free	>70	3000	DALI			ENEC	STOCK
													NEE	NEE

Technische eigenschappen

Referentie	ITSP31000AS3000DA
EAN code	5404042501399
ETIM code	

Elektrische eigenschappen

Systeem vermogen (W)	1000
LED vermogen (W)	
Aansluitspanning (Vac)	100-277
Frequentie (Hz)	50/60
Driver inbegrepen	ja
Driver intern/extern	extern
Driver merk	Inventronics
Driver type	
Dimbaar	DALI
Flicker free	nee
Power factor	>0.95
THD	
Driver output (V)	
Driver output (mA)	
Isolatieklasse	I
Energie klasse	D
Aantal op 16A B curve	
Aantal op 16A C curve	
Aantal op 16A D curve	
Inrush current driver	

Garantie en certificatie

ENEC	nee
Garantie (jaar)	(exclusief batterijen)

Lichttechnische eigenschappen

Lichtbundel(°)	117x34
Kleurtemperatuur (K)	3000
Kleurweergave CRI	>70
UGR	
Kleurvastheid SDCM	
Lumen output (Lm)	143000
Lm/W	143
Flux code	
Ledchip	
Ledfabrikant	
Aantal LEDs	
Fotobiologische klasse	

Afmeting en materiaal eigenschappen

Afmetingen (LxBxH)	815x706x213mm
Gewicht (kg)	31,5
Kleur	
Werktemperatuur (°C)	
IP waarde	IP66
IK waarde	IK10
UV bestendig	nee
Zeewater bestendig	nee
UL 94	
Aantal in bulk	1
Aantal op pallet	
Minimum bestelaantal	1
Stockartikel	nee
EPA	

Lumen distribution

Distance curve:

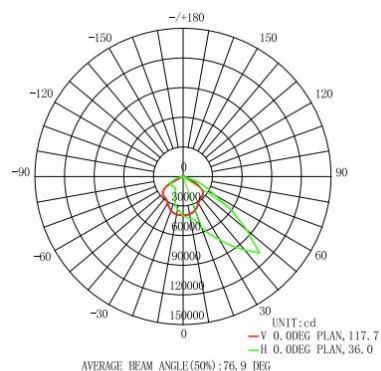

T2(117*34°)

Spectrum distribution

Lumendrop

Afmetingen

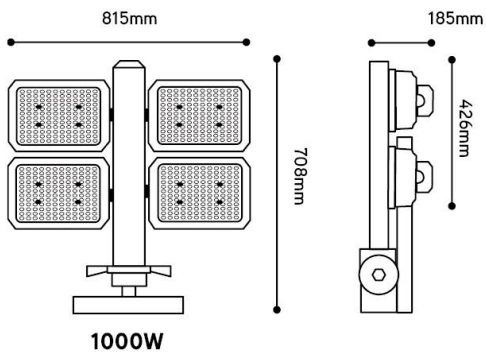

Aansluitschema