

















Extreem efficiënt armatuur met zeer hoge levensduur, uitgerust met kwaliteitsdrivers en EMC5050 ledchips, efficiëntie tot 180lm/W afhankelijk van type lens. Ingebouwde overspanningsbeveiliging 20kV. Bijzonder geschikt voor high-end toepassingen zoals sportvelden waar veel licht nodig is met weinig armaturen. Standaard dimbaar 1-10V. Opties DALI dimbaar, aparte driverbox, valbeveiliging, louvre, balbeveiliging en lasertool voor precisie afstelling.

| | | | | | | | | | | | | | | |
|---|---|---|---|---|---|---|---|---|---|--|---|---|---|---|
|  |  |  |  |  |  |  |  |  |  |  |  |  |  |  |
| IP66 | IK10 | 15 | 5 | tot 145 | 0,98 | 85.000 L80 | JA | >70 | 4000 | 1-10V | EMC5050 | >26 | NEE | NEE |

Technische eigenschappen

| | |
|------------|---------------|
| Referentie | ITSP800154000 |
| EAN code | 5420076287252 |
| ETIM code | EC001744 |

Elektrische eigenschappen

| | |
|------------------------|------------|
| Systeem vermogen (W) | 791 |
| LED vermogen (W) | 775 |
| Aansluitspanning (Vac) | 100-277 |
| Frequentie (Hz) | 47-63 |
| Driver inbegrepen | ja |
| Driver intern/extern | extern |
| Driver merk | TCL |
| Driver type | 805H-200DQ |
| Dimbaar | 1-10V |
| Flicker free | ja |
| Power factor | 0,98 |
| THD | <20% |
| Driver output (V) | |
| Driver output (mA) | |
| Isolatieklasse | I |
| Energie klasse | D |
| Aantal op 16A B curve | |
| Aantal op 16A C curve | |
| Aantal op 16A D curve | |
| Inrush current driver | 220 |

Garantie en certificatie

| | |
|-----------------|--------------------------|
| ENEC | nee |
| Garantie (jaar) | 5 (exclusief batterijen) |

Lichttechnische eigenschappen

| | |
|------------------------|----------|
| Lichtbundel(°) | 15 |
| Kleurtemperatuur (K) | 4000 |
| Kleurweergave CRI | >70 |
| UGR | >26 |
| Kleurvastheid SDCM | 3 |
| Lumen output (Lm) | 111490 |
| Lm/W | 145 |
| Flux code | |
| Ledchip | EMC5050 |
| Ledfabrikant | Tiandian |
| Aantal LEDs | 608 |
| Fotobiologische klasse | RG2 |

Afmeting en materiaal eigenschappen

| | |
|----------------------|---------------|
| Afmetingen (LxBxH) | 801x391x160mm |
| Gewicht (kg) | 19 |
| Kleur | zwart |
| Werktemperatuur (°C) | -40~+45 |
| IP waarde | IP66 |
| IK waarde | IK10 |
| UV bestendig | ja |
| Zeewater bestendig | ja |
| UL 94 | |
| Aantal in bulk | 1 |
| Aantal op pallet | 0 |
| Minimum bestelaantal | 1 |
| Stockartikel | nee |

ITSP800154000 - Integrasports 800W 15gr 4000K IP66 IK10 zwart

Lumen distribution

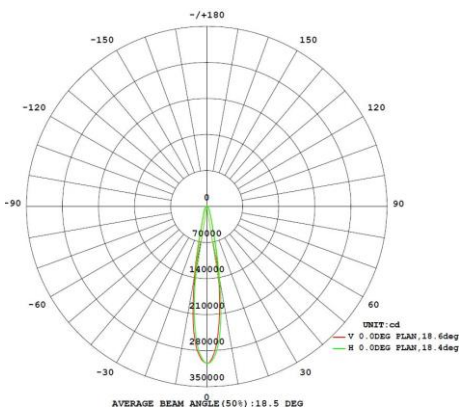

Distance curve:

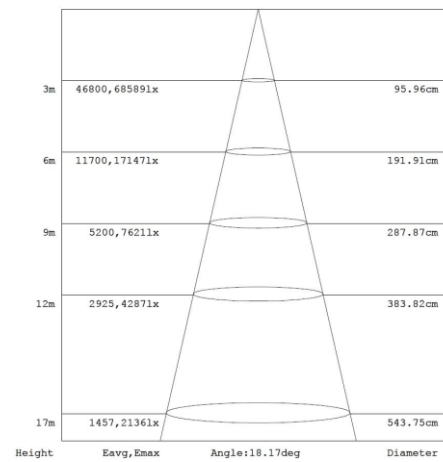

Spectrum distribution

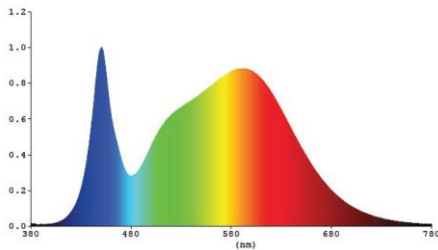

Lumendrop

Applies to products series:
Lightning 5050

| Parameter | Value |
|-------------------------|-------------|
| Life Time Drive Current | 120mA |
| Case Temperature(Tc) | 55/85/105°C |
| Number of Units | 25 |

| Tc | Lxx/Byy | 10 | 20 | 50 |
|-------|---------|------------|-------------|-------------|
| 55°C | 70 | 109,361hrs | 118,840 hrs | 133,038 hrs |
| | 80 | 70,160 hrs | 75,052 hrs | 84,309 hrs |
| | 90 | 35,583 hrs | 36,428 hrs | 41,212 hrs |
| 85°C | 70 | 94,644 hrs | 99,462 hrs | 137,893 hrs |
| | 80 | 60,717 hrs | 63,041 hrs | 85,246 hrs |
| | 90 | 30,165 hrs | 30,916 hrs | 39,580 hrs |
| 105°C | 70 | 86,071 hrs | 87,908 hrs | 106,171 hrs |
| | 80 | 55,151 hrs | 55,922 hrs | 67,107 hrs |
| | 90 | 27,572 hrs | 28,245 hrs | 32,650 hrs |

Afmetingen

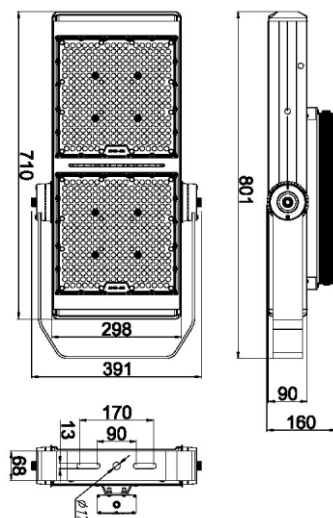

Aansluitschema



20KV SPD