

















Extreem efficiënt armatuur met zeer hoge levensduur, uitgerust met kwaliteitsdrivers en EMC5050 ledchips, efficiëntie tot 180lm/W afhankelijk van type lens. Ingebouwde overspanningsbeveiliging 20kV. Bijzonder geschikt voor high-end toepassingen zoals sportvelden waar veel licht nodig is met weinig armaturen. Standaard dimbaar 1-10V. Opties DALI dimbaar, aparte driverbox, valbeveiliging, louvre, balbeveiliging en lasertool voor precisie afstelling.

														
IP66	IK10	90	5	tot 168	0,98	85.000 L80	JA	>70	3000	1-10V	EMC5050	>26	NEE	NEE

Technische eigenschappen

Referentie	ITSP800903000
EAN code	5420076287283
ETIM code	EC001744

Elektrische eigenschappen

Systeem vermogen (W)	789
LED vermogen (W)	772
Aansluitspanning (Vac)	100-277
Frequentie (Hz)	47-63
Driver inbegrepen	ja
Driver intern/extern	extern
Driver merk	TCL
Driver type	805H-200DQ
Dimbaar	1-10V
Flicker free	ja
Power factor	0,98
THD	<20%
Driver output (V)	
Driver output (mA)	
Isolatieklasse	I
Energie klasse	C
Aantal op 16A B curve	
Aantal op 16A C curve	
Aantal op 16A D curve	
Inrush current driver	220

Garantie en certificatie

ENEC	nee
Garantie (jaar)	5 (exclusief batterijen)

Lichttechnische eigenschappen

Lichtbundel(°)	90
Kleurtemperatuur (K)	3000
Kleurweergave CRI	>70
UGR	>26
Kleurvastheid SDCM	3
Lumen output (Lm)	130313
Lm/W	168
Flux code	
Ledchip	EMC5050
Ledfabrikant	Tiandian
Aantal LEDs	608
Fotobiologische klasse	RG2

Afmeting en materiaal eigenschappen

Afmetingen (LxBxH)	801x391x160mm
Gewicht (kg)	19
Kleur	zwart
Werktemperatuur (°C)	-40~+45
IP waarde	IP66
IK waarde	IK10
UV bestendig	ja
Zeewater bestendig	ja
UL 94	
Aantal in bulk	1
Aantal op pallet	0
Minimum bestelaantal	1
Stockartikel	nee

ITSP800903000 - Integrasports 800W 90gr 3000K IP66 IK10 zwart

Lumen distribution

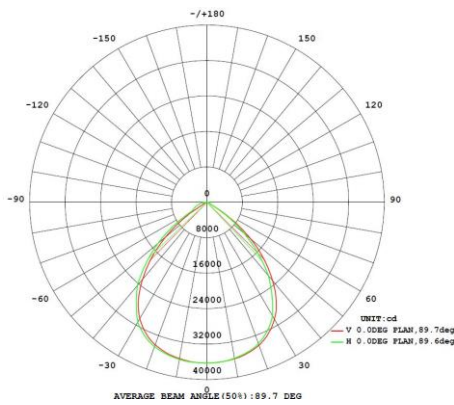

Spectrum distribution

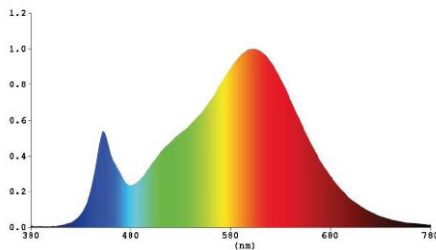

Distance curve:

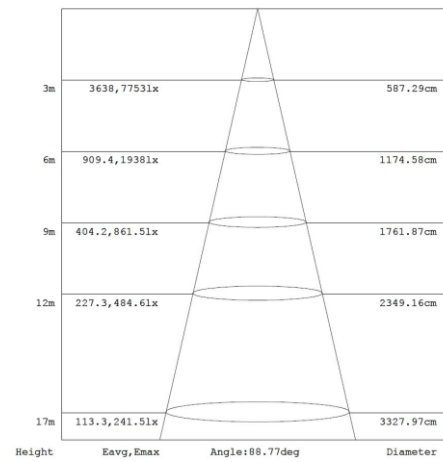

Height: Eavg, Emax Angle: 88.77deg Diameter

Lumendrop

Applies to products series:
Lightning 5050

Parameter	Value
Life Time Drive Current	120mA
Case Temperature(Tc)	55/85/105°C
Number of Units	25

Tc	Lxx/Byy	10	20	50
55°C	70	109,361hrs	118,840 hrs	133,038 hrs
	80	70,160 hrs	75,052 hrs	84,309 hrs
	90	35,583 hrs	36,428 hrs	41,212 hrs
85°C	70	94,644 hrs	99,462 hrs	137,893 hrs
	80	60,717 hrs	63,041 hrs	85,246 hrs
	90	30,165 hrs	30,916 hrs	39,580 hrs
105°C	70	86,071 hrs	87,908 hrs	106,171 hrs
	80	55,151 hrs	55,922 hrs	67,107 hrs
	90	27,572 hrs	28,245 hrs	32,650 hrs

Afmetingen

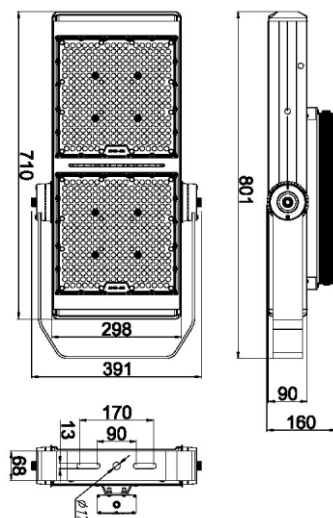

Aansluitschema



20KV SPD