















Power High Bay Performance range met Power Switch 80W-120W-150W en color switch 3000K-4000K-5000K. De IP65 behuizing met geïntegreerde ventilatiesleuven garandeert een optimale luchtdoorstroming en koeling. PHBP is uitgerust met performante leds met lange levensduur. PHBP beschikt over ENEC certificatie en is standaard voorzien van een Poly Carbonaat cover. Het toestelrendement gaat tot 175lm/W bij 4000K met standaard lichtbundel van 120°. Met de optionele muurbeugel is het mogelijk om het toestel in een vaste positie te monteren op wand of plafond. Klaar voor smart lighting toepassingen. Verschillende extra functionaliteiten zijn mogelijk via de standaard Zhaga-connector.

 IP65	 IK09	 120	 Garantie 5	 lm/W tot 175	 PF 0,9	 70.000 L80B50	 Flicker-Free	>80 CRI icon" data-bbox="516 296 569 335"/> >80	 CCT 30-40-5000K	 DIM 1-10V	 SMD2835	 ENEC	 STOCK
----------------------------------------------------------------------------------------	----------------------------------------------------------------------------------------	---------------------------------------------------------------------------------------	----------------------------------------------------------------------------------------------	------------------------------------------------------------------------------------------------	------------------------------------------------------------------------------------------	-------------------------------------------------------------------------------------------------	------------------------------------------------------------------------------------------------	-------------------------------------------------	---------------------------------------------------------------------------------------------------	----------------------------------------------------------------------------------------------	---------------------------------------------------------------------------------------------	------------------------------------------------------------------------------------------	-------------------------------------------------------------------------------------------

Technische eigenschappen

Referentie	PHBP3150PCTSZ
EAN code	5404042517529
ETIM code	EC001716

Elektrische eigenschappen

Systeem vermogen (W)	166,67
LED vermogen (W)	
Aansluitspanning (Vac)	100-277
Frequentie (Hz)	50/60
Driver inbegrepen	ja
Driver intern/extern	extern
Driver merk	Sosen
Driver type	constant current
Dimbaar	1-10V
Flicker free	nee
Power factor	0,9
THD	<20%
Driver output (V)	
Driver output (mA)	
Isolatieklasse	I
Energie klasse	C
Aantal op 16A B curve	
Aantal op 16A C curve	
Aantal op 16A D curve	
Inrush current driver	

Garantie en certificatie

ENEC	nee
Garantie (jaar)	5 (exclusief batterijen)

Lichttechnische eigenschappen

Lichtbundel(°)	120
Kleurtemperatuur (K)	30-40-5000K
Kleurweergave CRI	>80
UGR	
Kleurvastheid SDCM	<5
Lumen output (Lm)	26250
Lm/W	175
Flux code	
Ledchip	SMD2835
Ledfabrikant	XUYU
Aantal LEDs	
Fotobiologische klasse	

Afmeting en materiaal eigenschappen

Afmetingen (LxBxH)	300x300x149mm
Gewicht (kg)	2,3
Kleur	zwart
Werktemperatuur (°C)	-30~+45
IP waarde	IP65
IK waarde	IK09
UV bestendig	ja
Zeewater bestendig	nee
UL 94	
Aantal in bulk	1
Aantal op pallet	90
Minimum bestelaantal	1
Stockartikel	ja
EPA	

Lumen distributio

Distance curve:

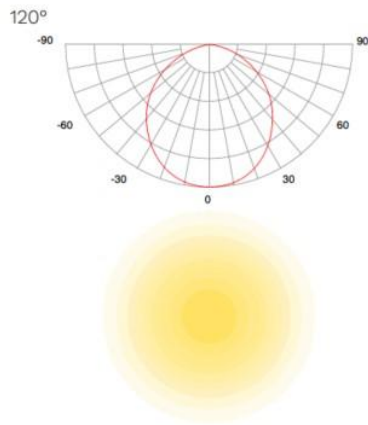

Spectrum distributio

Lumendrop

Afmetingen

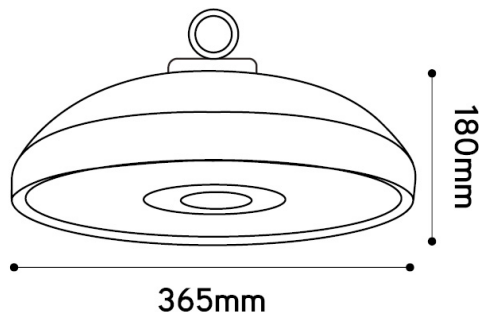

Aansluitschema

