















PHBS31504DA - Klokkarmatuur PHB S3 150W 4000K DALI



Power High Bay 150W 4000K. De IP65 behuizing met geïntegreerde ventilatiesleuven garandeert een optimale luchtdoorstroming en koeling. PHB is uitgerust met performante Lumileds met zeer lange levensduur. PHB beschikt over ENEC certificatie en is standaard voorzien van een opaal polycarbonaat cover voor een aangename en minder verblindende verlichting. Toestelrendement tot 175lm/W bij 4000K, standaard lichtbundel van 120°. Met de optionele muurbeugel is het mogelijk om het toestel in een vaste positie te monteren op wand of plafond. Klaar voor smart lighting toepassingen. Raadpleeg ons hoofdstuk smart lighting voor meer informatie. Inclusief aansluitkabel van 150cm. Met DALI.

													
IP65	IK09	120	5	tot 175	0,90	> 100.000 L80B50	Flicker-Free	80	4000	DALI	SMD2835	NEE	JA

Technische eigenschappen

Referentie	PHBS31504DA
EAN code	5404042517505
ETIM code	EC001716

Elektrische eigenschappen

Systeem vermogen (W)	166,66
LED vermogen (W)	
Aansluitspanning (Vac)	100-277
Frequentie (Hz)	50/60
Driver inbegrepen	ja
Driver intern/extern	extern
Driver merk	Sosen
Driver type	constant current
Dimbaar	DALI
Flicker free	nee
Power factor	0,90
THD	<20%
Driver output (V)	
Driver output (mA)	
Isolatieklasse	I
Energie klasse	C
Aantal op 16A B curve	
Aantal op 16A C curve	
Aantal op 16A D curve	
Inrush current driver	

Garantie en certificatie

ENEC	nee
Garantie (jaar)	5 (exclusief batterijen)

Lichttechnische eigenschappen

Lichtbundel(°)	120
Kleurtemperatuur (K)	4000
Kleurweergave CRI	80
UGR	
Kleurvastheid SDCM	<5
Lumen output (Lm)	26250
Lm/W	175
Flux code	
Ledchip	SMD2835
Ledfabrikant	XUYU
Aantal LEDs	
Fotobiologische klasse	

Afmeting en materiaal eigenschappen

Afmetingen (LxBxH)	320x320x100mm
Gewicht (kg)	1,9
Kleur	zwart
Werktemperatuur (°C)	-30~+45
IP waarde	IP65
IK waarde	IK09
UV bestendig	ja
Zeewater bestendig	nee
UL 94	
Aantal in bulk	1
Aantal op pallet	90
Minimum bestelaantal	1
Stockartikel	ja
EPA	

Lumen distributie

Distance curve:

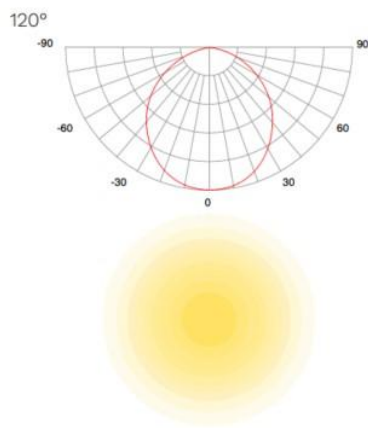

Spectrum distributie

Lumendrop

PHBS31504DA - Klokkarmatuur PHB S3 150W 4000K DALI

Afmetingen

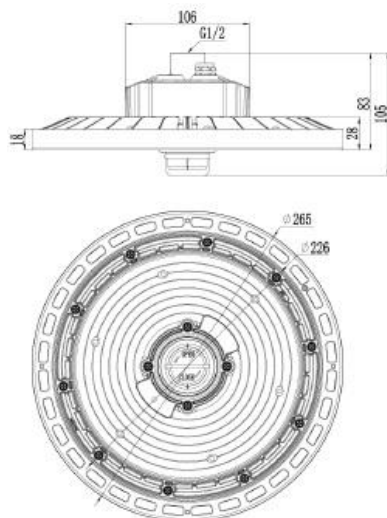

Aansluitschema

