

QT led paneel 1195x295mm met smalle randen van slechts 19mm breed. Het aluminium frame is afgewerkt met witte poedercoating RAL9016. Uitgerust met 216 SMD4014 leds. Gelakte backplate met voorgemonteerde houders voor pendelmontage of valbeveiliging. Geleverd zonder driver. Steeds één driver per paneel apart bijbestellen. Lumenoutput tot 115lm/W. Geschikt voor 30W 750mA of 36W 900mA driver. Diverse montage accessoires beschikbaar. ENEC gekeurd

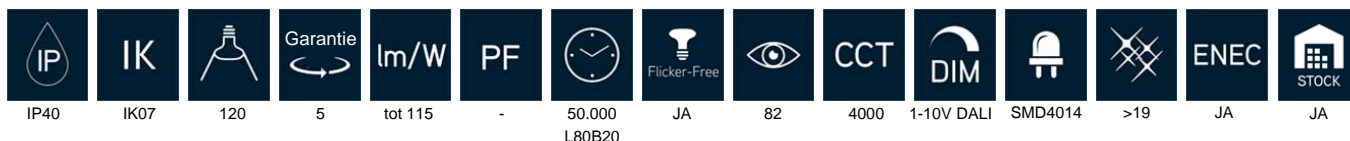

### Technische eigenschappen

Referentie	QT301203640
EAN code	5420076262815
ETIM code	EC002892

### Elektrische eigenschappen

Systeem vermogen (W)	36
LED vermogen (W)	36
Aansluitspanning (Vac)	45VDC
Frequentie (Hz)	CC
Driver inbegrepen	nee
Driver intern/extern	extern
Driver merk	-
Driver type	-
Dimbaar	1-10V DALI
Flicker free	ja
Power factor	-
THD	-
Driver output (V)	27-42V=
Driver output (mA)	900
Isolatieklasse	III
Energie klasse	E
Aantal op 16A B curve	-
Aantal op 16A C curve	-
Aantal op 16A D curve	-
Inrush current driver	-

### Garantie en certificatie

ENEC	ja
Garantie (jaar)	5 (exclusief batterijen)

### Lichttechnische eigenschappen

Lichtbundel(°)	120
Kleurtemperatuur (K)	4000
Kleurweergave CRI	82
UGR	>19
Kleurvastheid SDCM	3
Lumen output (Lm)	3975
Lm/W	115
Flux code	48 79 96 100 100
Ledchip	SMD4014
Ledfabrikant	Hongli
Aantal LEDs	216
Fotobiologische klasse	RG0

### Afmeting en materiaal eigenschappen

Afmetingen (LxBxH)	1195x295x8mm
Gewicht (kg)	3
Kleur	wit RAL9016
Werktemperatuur (°C)	40°C
IP waarde	IP40
IK waarde	IK07
UV bestendig	ja
Zeewater bestendig	nee
UL 94	-
Aantal in bulk	5
Aantal op pallet	0
Minimum bestelaantal	1
Stockartikel	ja
EPA	-

## QT301203640 - Led paneel QT 36W 300x1200 4000K RAL9016 ENEC

### Lumen distributie

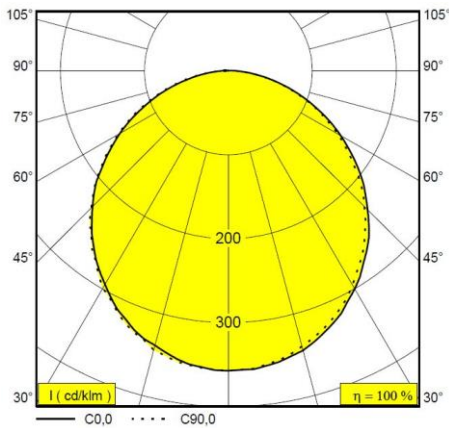

### Distance curve:

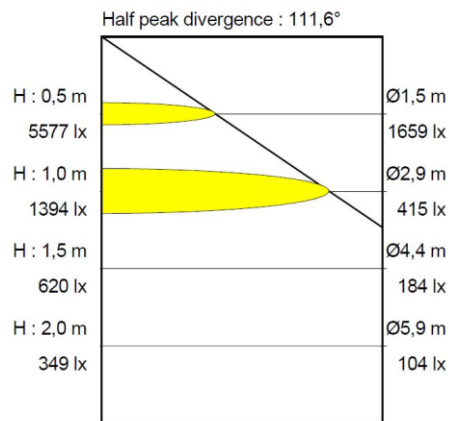

### Spectrum distributie

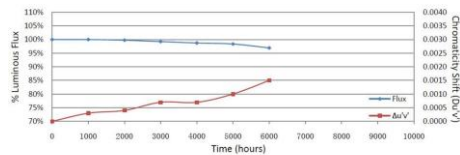
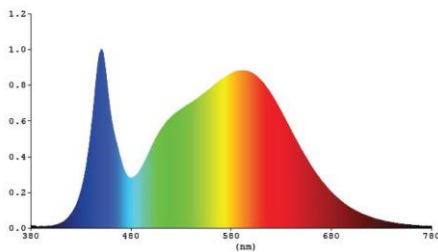

QT/QTU 216x SMD4014	
Tc 55°C	
L70B50	70000H
L80B20	50000H
L90B10	38000H

### Accessoires

QTD30W5	QT driver 30W flicker-free niet dimbaar	
QTD36W5	QT driver 36W flicker-free niet dimbaar	
UNIDRIVER50	Ledpaneel unidriver 30~50W 1-10V/DALI/push dim	
QTRF30120W	Inbouwframe voor led paneel 300x1200 RAL9016	
QTSF30120W	Opbouwframe voor led paneel 300x1200 RAL9016	
FLAIR30120B	Opbouwframe Flair 30x120 zwart RAL9005	
FLAIR30120W	Opbouwframe Flair 30x120 wit RAL9010	
PL-FIX	Opbouw bevestigingsset met 4 beugels	
PL-CLAMP	Bevestigingsset met 4 klemveren	
QTPEND	Pendelset 4 bevestigingen voor led paneel QT	
PL-PEND2	Pendelset 1m met 2 ophangpunten	
PL-CONNECT	Plafonddoos + 2,5m transparante kabel 3G0,75	
PL-PROTECT	Valbeveiliging 1m met zelfsluitende haak	

### Afmetingen

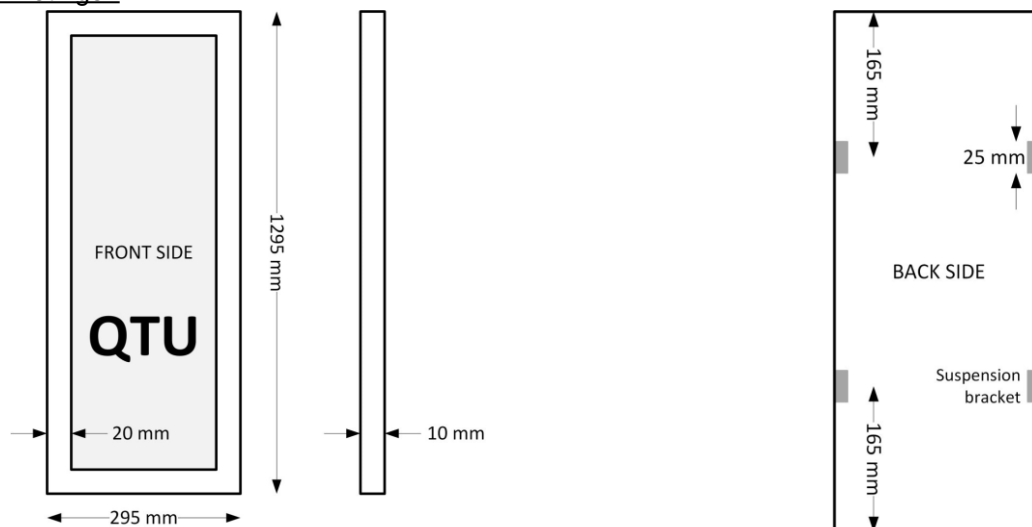

### Aansluitschema

#### BASIC NON DIM

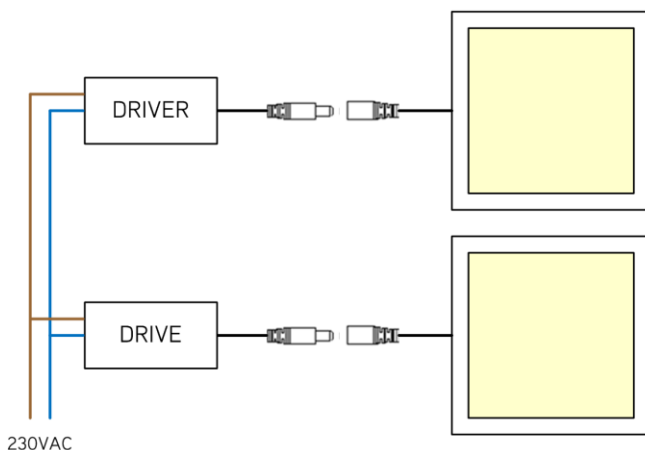

#### DIM 1-10V/DALI

