



Panneau LED QT 595x595mm avec des bords étroits de seulement 19mm de large. Châssis en aluminium thermolaqué en blanc RAL9016. Equipé de 216 leds SMD4014. Plaque de base laquée avec supports pré-assemblés pour montage pendulaire ou antichute. Livré sans driver. Toujours commander un driver séparément par panneau. Débit lumineux jusqu'à 115 lm/W. Convient pour un driver 30W 750mA ou 36W 900mA. Différents accessoires de montage disponibles. Certification ENEC



Specifications technique

Reference	QT60603640
EAN code	5420076262839
ETIM code	EC002892

Specifications électrique

Puissance système (W)	36
Puissance led (W)	36
Tension (Vac)	27-42V=
Fréquence (Hz)	CC
Contrôleur inclus	no
Contrôleur in/externe	externe
Driver marque	Boke
Driver référence	-
Dimmable	1-10V/DALI
Flicker free	oui
Power factor	-
Taux d'harmonique	
Driver output (V)	27-42V=
Driver output (mA)	900
Classe d'isolation	III
Classe d'énergie	A+*
N° sur disj. 16A type B	
N° sur disj. 16A type C	-
N° sur disj. 16A type D	-
Inrusch current driver	-

Garantie et certification

Durée de vie (h)	50.000 L80B20
Garantie (ans)	5 (hors batteries)
ENEC	oui

Propriétés photométriques

Angle rayonnement (°)	120
Temp. de couleur (K)	4000
Rendu de couleurs CRI	82
UGR	>19
Solidité de couleurs	3
Sortie de lumen (Lm)	3975
Lm/W	115
Flux code	47 79 96 100 100
Puce led	SMD4014
Fournisseur led	Hongli
Nombre de puce led	216
Classe photobiologique	RG0

Dimensions et caractéristiques du matériau

Dimensions (LxlxH)	595x595x8mm
Poids (kg)	3
Couleur	blanc RAL9016
Temp. de travail (°C)	40°C
Valeur IP	IP40
Valeur IK	IK07
Résistant aux UV	oui
Résistant à l'eau de mer	no
UL94	-
Nombre en vrac	5
Nombre sur palette	70
Quantité minimum	1
Article en stock	oui
EPA	

QT60603640 Panneau led QT 36W 600x600 4000K RAL9016 ENEC

Lumen distributio

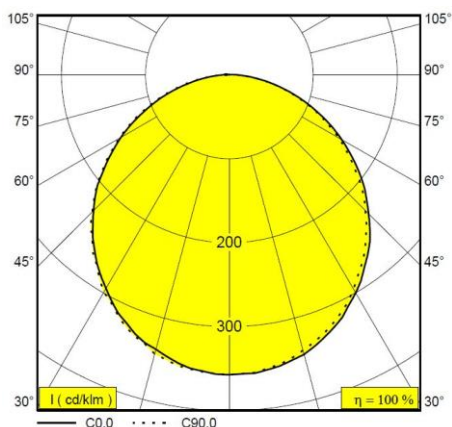

Distance curve:

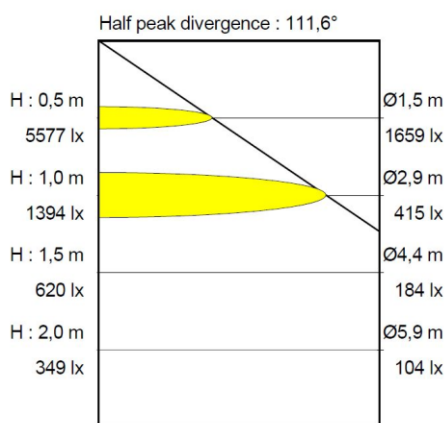

Spectrum distributio

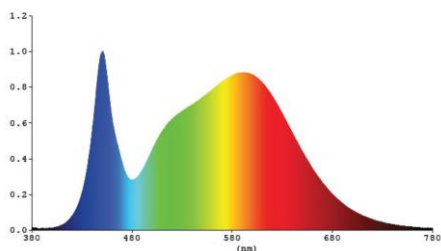



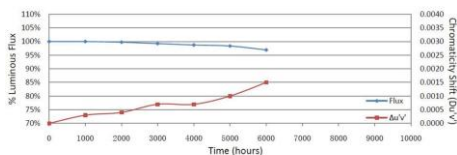









Lumendrop



QT/QTU 216x SMD4014	
Tc 55°C	
L70B50	70000H
L80B20	50000H
L90B10	38000H

Accessoires

QTD30W5	Driver QT 30W flicker-free non-réglable	
QTD36W5	Driver QT 36W flicker-free non-réglable 5j gar	
UNIDRIVER50	Panneau led unidriver 30-50W 1-10V/DALI/push dim	
QTSF6060W	Cadre apparent pour panneau led 600x600 RAL9016	
QTRF6060W	Cadre encastré pour panneau led 600x600 RAL9016	
FLAIR6060B	Cadre apparent Flair 60x60 noir RAL9005	
FLAIR6060W	Cadre apparent Flair 60x60 blanc RAL9010	
PL-FIX	Set de montage apparent avec 4 supports	
PL-CLAMP	Kit de montage avec 4 ressorts de serrage	
QTPEND	Set suspension 4 fixations pour panneau led QT	
PL-PEND2	Kit de suspension 1m avec 2 fixations	
PL-CONNECT	Boîte de connexion + 2,5m câble transparent 3G0,75	
PL-PROTECT	Protection antichute 1m avec crochet	

Dimensions



Schéma de câblage

BASIC NON DIM



DIM 1-10V/DALI

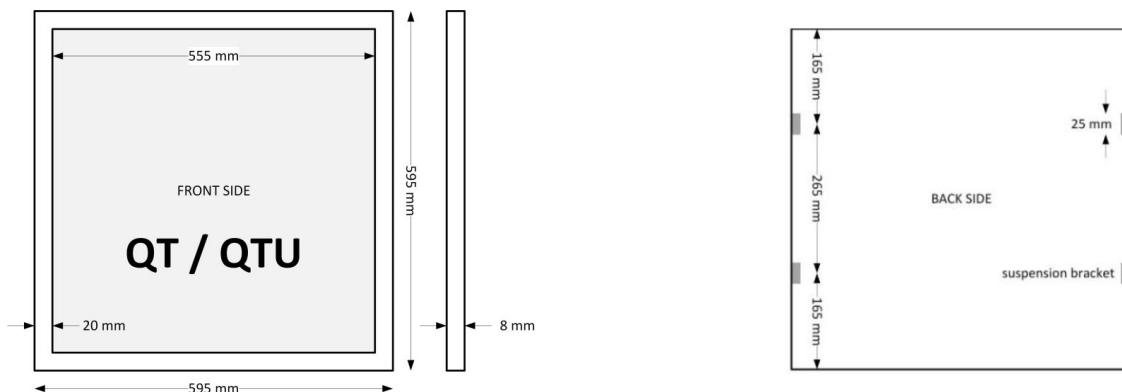
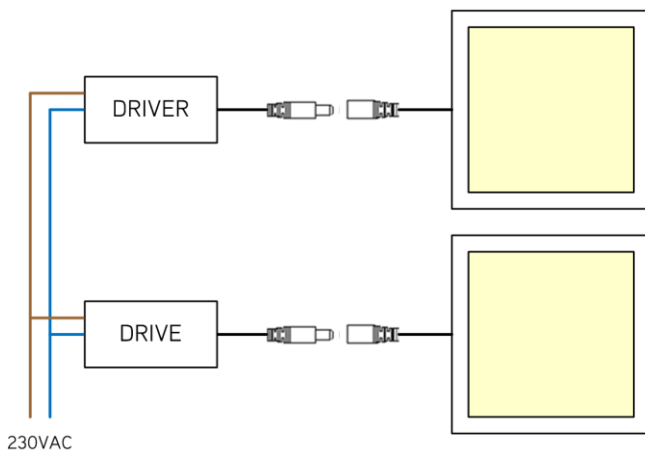